

Infinity *Reference 1052w 10" Woofer – Technical Data*

CAR AUDIO

SPECIFICATIONS

DIAMETER:	10" (250 mm)
SENSITIVITY (2.83 V @ 1 m):	91 dB
POWER HANDLING:	250 W _{RMS} 1000 W _{PEAK}
FREQUENCY RESPONSE:	25 ~ 400 Hz
NOMINAL IMPEDANCE:	2 or 8 OHMS
VOICE-COIL DIAMETER:	2.0" (51.0 mm)

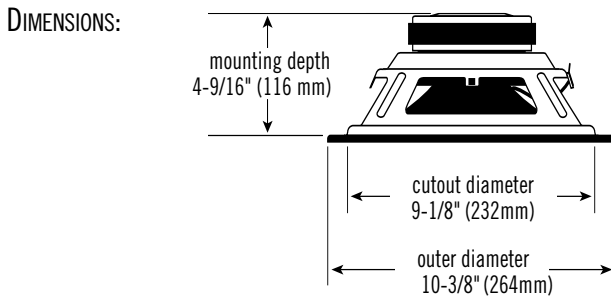

THIELE-SMALL PARAMETERS

VOICE COIL DC RESISTANCE:	R_{EVC} (OHMS)	1.85
VOICE COIL INDUCTANCE @ 1 kHz:	L_{EVC} (MH)	1.82
DRIVER RADIATING AREA:	S_D (IN ²)	55.03
	S_D (M ²)	355.00
MOTOR FORCE FACTOR:	BL (TM)	9.66
COMPLIANCE VOLUME:	V_{AS} (FT ³)	1.41
	V_{AS} (LITERS)	39.80
SUSPENSION COMPLIANCE:	C_{MS} (μM/N)	221.00
MOVING MASS, AIR LOAD:	M_{MS} (GRAMS)	137.90
MOVING MASS, DIAPHRAGM:	M_{MD} (GRAMS)	134.10
FREE-AIR RESONANCE:	F_S (HZ)	28.80
MECHANICAL Q:	Q_{MS}	6.30
ELECTRICAL Q:	Q_{ES}	0.50
TOTAL Q:	Q_{TS}	0.46
MAGNETIC-GAP HEIGHT:	H_{AG} (IN)	3/8
	H_{AG} (MM)	9.00
VOICE-COIL HEIGHT:	H_{VC} (IN)	1-5/16
	H_{VC} (MM)	34
MAXIMUM EXCURSION:	X_{MAX} (IN)	1/2
	X_{MAX} (MM)	12.50

SEALED BOX VOLUME (INCLUDES DRIVER DISPLACEMENT)

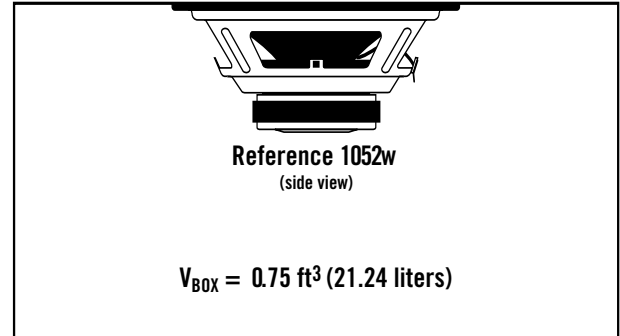

SEALED ENCLOSURE FREQUENCY RESPONSE @ 2.83 V

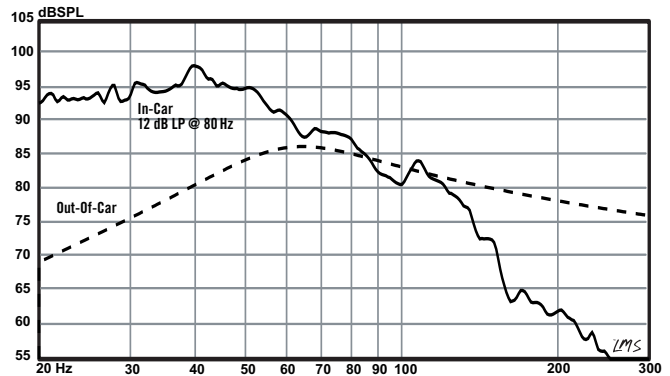

SEALED ENCLOSURE CONE EXCURSION @ 250 W

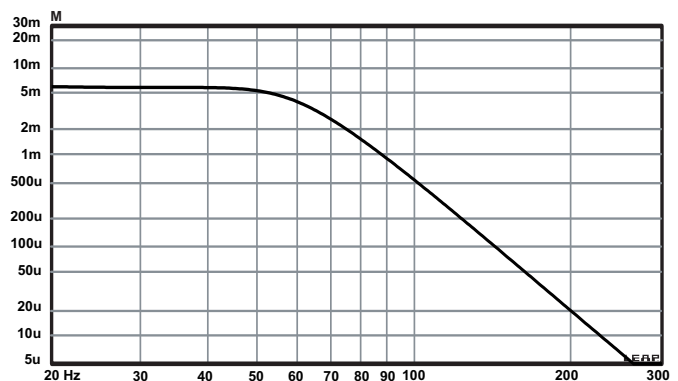

Infinity *Reference 1052w 10" Woofer – Technical Data*

CAR AUDIO

VENTED BOX VOLUME (INCLUDES DRIVER/PORT DISPLACEMENTS)

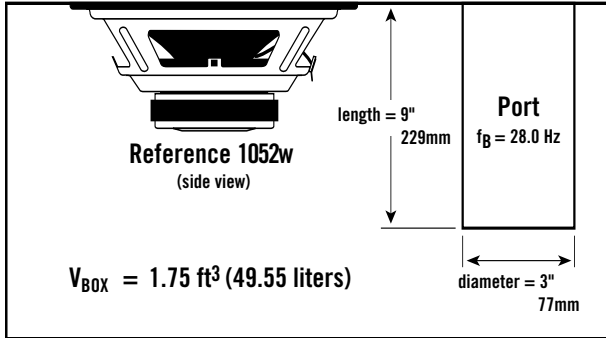

BANDPASS BOX VOLUME (INCLUDES DRIVER/PORT DISPLACEMENTS)

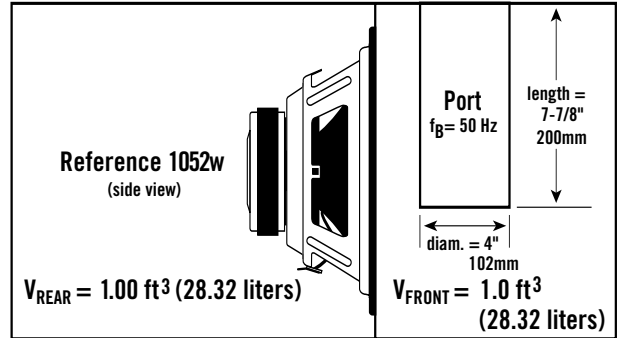

VENTED ENCLOSURE FREQUENCY RESPONSE @ 2.83 V

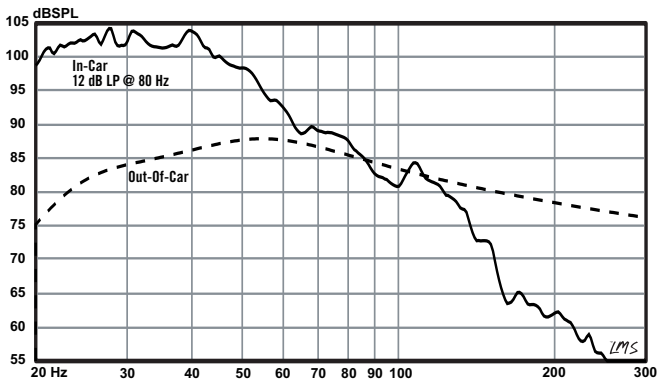

BANDPASS ENCLOSURE FREQUENCY RESPONSE @ 2.83 V

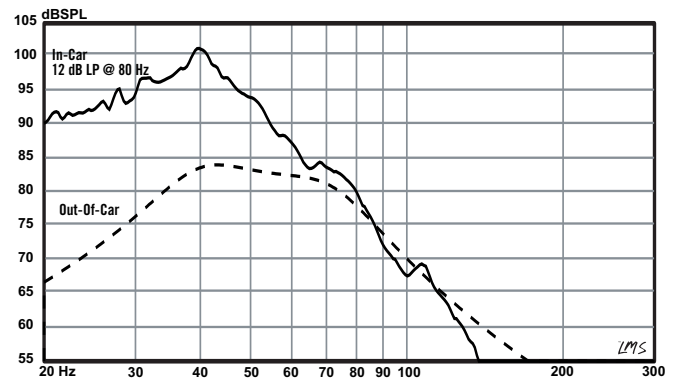

VENTED ENCLOSURE CONE EXCURSION @ 250 W

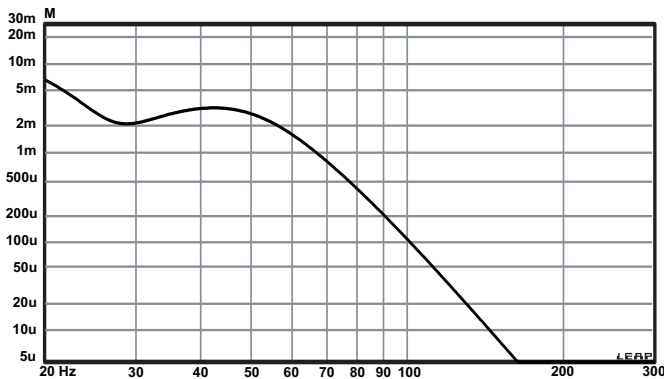

BANDPASS ENCLOSURE CONE EXCURSION @ 250 W

